

File Name	Specification for GHD 14.53" EFD	Spec No	EFD1453BC17
Type	Standard Product	Rev No	A/1

Specification for GHD 14.53" EFD

Product No. : EFD1453BC17

Type :

Version : A/1

Prepared by	Checked by	Approved by
JJ. Zhang	Kevin. Zhang	Yang. Deng

Email : sales@rgbdisp.com

Web : www.rgbdisp.com

RECORD OF REVISION

REV	COMMET	DATE
A/1	First issue	2018

CONTENTS

Page No.

1.	Technology Description	4
2.	Typical Applications	4
3.	General Description	4
4.	Mechanical Specifications	5
5.	Interface Signals	8
6.	Absolute Maximum Ratings	9
6.1	Electrical Maximum Ratings – for IC Only	9
6.2	Environmental Condition	9
7.	Electrical Specifications	10
7.1	Typical Electrical Characteristics	10
7.2	Timing Specifications of common mode	11
7.3	Timing Specifications of segment mode	12
8.	Specification of Quality Assurance	13
9.	Precaution for Using LCM	16

1. Technology Description

EFD (Energy Friendly Display) is a sunlight readable reflective display with extremely low power consumption characteristics. Due to the non-volatile memory feature of the technology, zero power is required to retain the image of the display. Energy is only required to change the displayed image. No backlighting is required, only ambient lighting from the surrounding is required or add front light in dark condition if necessary. Readability when under direct sunlight is excellent and good contrast from viewing at very wide angles are possible.

2. Typical Applications

This module is intended for general purpose graphic and character display applications. Suggested uses include instrumentation, remote control, electronic product or price label, point of sale display, general purpose indoor or outdoor signage and information display.

3. General Description

- Passive matrix memory display, Positive, reflective mode graphic module
- Mode: Bi-stable
- Color: Black & Green & Red & Amber
- Display resolution: 72 x 144 dots + Segment code
- Interface: 8-bit/4-bit data driver method
- Viewing angle: all angles (for inclinations of $<70^\circ$, $CR > 3$)
- DPI: 17 dpi
- Logic voltage: +3.0~ +5.0 V
- FPC connection

4. Mechanical Specifications

The mechanical detail is shown in Fig. 1 and summarized in Table 1 below.

Table 1

Parameter	Specifications	Unit
Outline dimensions	340.0(W) x 147.02(H) x 2.2(D)	mm
Viewing area	333.0(W) x 140.0(H)	mm
Active area	327(W) x 134(H)	mm
Display format	72(Horizontal) x 144(Vertical)	dots
Dot size	0.88(W) x 0.88(H)	mm
Dot spacing	0.015(W) x 0.015(H)	mm
Dot pitch for characters	0.895(W) x 0.895(H)	mm
Operation Temperature	From -20 to 80	°C
Storage Temperature	From -30 to 80	°C
Weight	TBD	gram

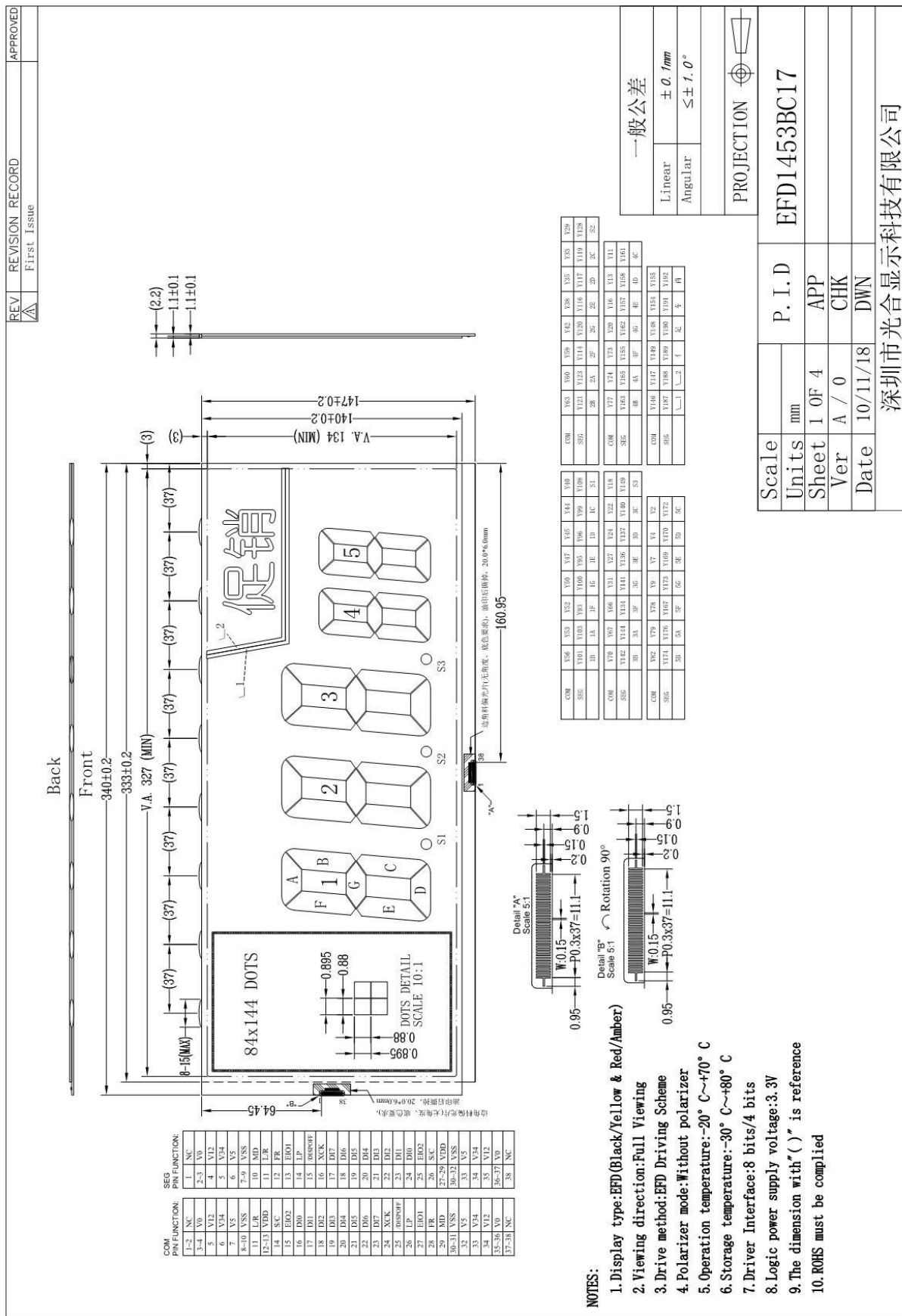

Figure 1: Module Specification

Figure 2: Block Diagram

5. Interface Signals

Table 2

Pin No.	Symbol	Description
1	VDD	Power supply
2	GND	Ground.
3	V0	Boas power supply pins for LCD drive voltage.
4	M	AC-converting signal input for LCD drive waveform.
5	DISPOFF	Control input for output of non-select level.
6	FLM	Frame signal.
7	LP_C	Shift clock input for shift register at common mode.
8	LP_S	Latch pulse input for display data at segment mode.
9	XCK	Clock input for taking display data at segment mode.
10-17	D0-D7	Input pin for display data 8-bit parallel input mode, input data into the 8 pins D0 ~ D7. Display data input.
18	BIAS_CTR	Bias control. High Bias while this pin is high.
19	VLCD_CTR	VLCD voltage control. High voltage while this pin is high.
20	VLCD_EN	VLCD output Enable. Active while this pin is high.

6. Absolute Maximum Ratings

6.1 Electrical Maximum Ratings - for IC only

Table 3

Parameter	Symbol	Conditions	Min.	Max.	Unit
Supply voltage	$V_{DD} - V_{SS}$	TA = + 25°C, Referenced to VSS = 0V	-0.3	+7.0	V
	$V_0 - V_{SS}$		0	+40.0	V
	V_{IN}		-0.3	$V_{DD}+0.3$	V

Note1: TA = + 25°C.

Note2: The maximum applicable voltage on any pin with respect to VSS (0V).

Note3: The modules may be destroyed if they are used beyond the absolute maximum ratings.

6.2 Environmental Condition

Table 4

Item	Operating temperature (Topr)		Storage Temperature (Tstg) (Note1)		Remark
	Min.	Max.	Min.	Max.	
Ambient temperature	-20°C	+80°C	-30°C	+80°C	Dry
Humidity (Note 1)	90% max. RH for Ta ≤ 40°C < 50°C RH for 40°C < Ta ≤ Maximum operating temperature			No condensation	
Packing vibration (GB/T5170.14-2009)	Frequency range:10Hz~50Hz Acceleration of gravity:5G X,Y,Z 30 min for each direction.			3 directions	

Note 1: Product cannot sustain at extreme storage conditions for long time.

7. Electrical Specifications

7.1 Typical Electrical Characteristics

At $T_a = +25^{\circ}\text{C}$, $V_{DD} = +3.0\text{V}\pm 5\%$, $V_{SS} = 0\text{V}$

Table 5

Parameter	Symbol	Conditions	Min.	Typ.	Max.	Unit
Supply voltage (System)	$V_{DD}-V_{SS}$		3.0	3.3	5.25	V
	V_{LCD}^*		-	23.7	-	V
Input signal voltage low	V_{IL}		0	-	$0.2V_{DD}$	V
Input signal voltage high	V_{IH}		$0.8 V_{DD}$	-	V_{DD}	V
Supply current	I_{DD}	$V_{DD}= 3.0\text{V}$	-	40	-	mA

*Internally Generated

7.2 Timing Specifications of common mode

At $T_a = +20^\circ\text{C}$, $V_{DD} = +5.0\text{V} \pm 5\%$, $\text{GND} = 0\text{V}$

Table 6

Symbol	Parameter	Min.	Typ.	Max.	Unit
t_{WLPH}	Latch pulse "H" pulse width	-	5.3	-	ms
t_{R}	Input signal rise time	-	36	-	ns
t_{F}	Input signal fall time	-	32	-	ns
t_{SD}	DISPOFF removal time	-	400	-	ns
t_{WDL}	DISPOFF enable pulse width	-	53	-	ms

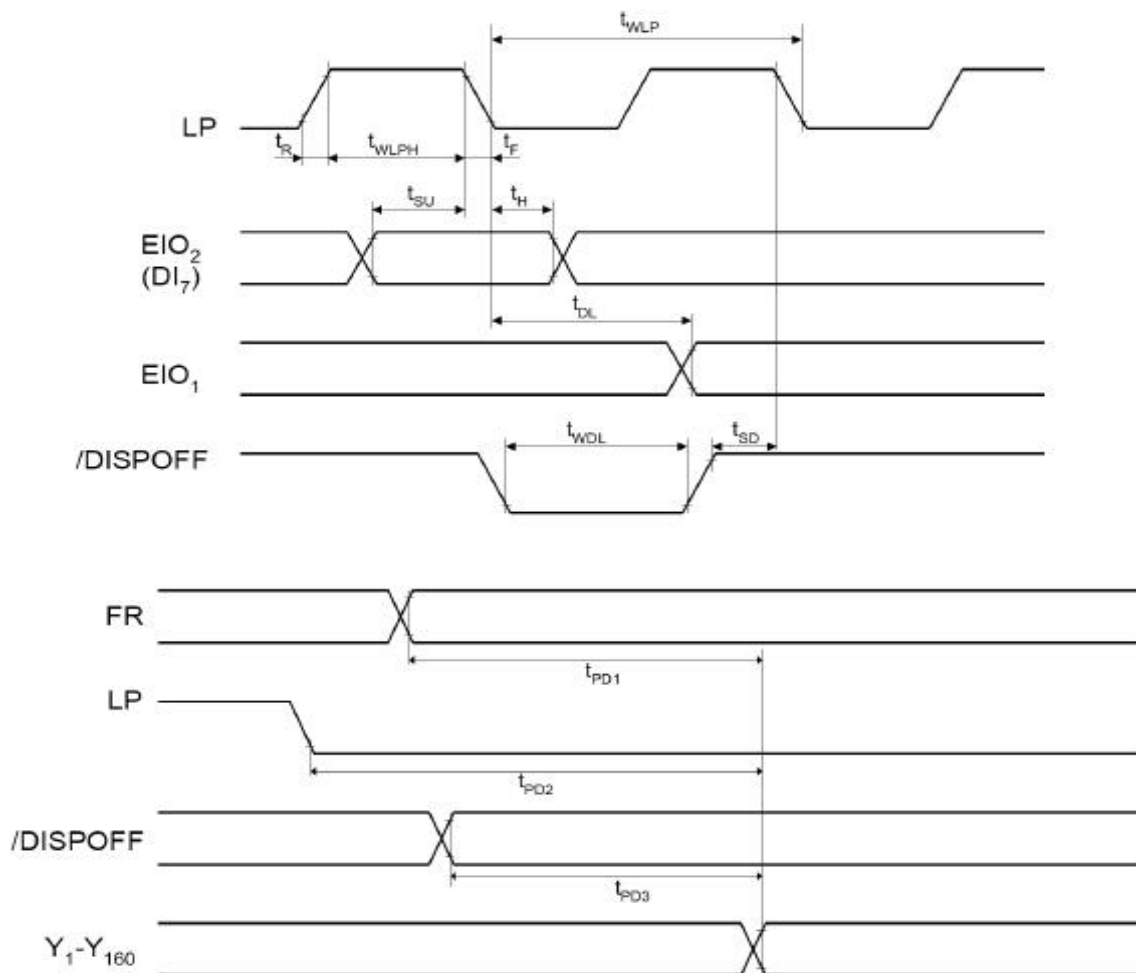

Figure 3: Timing characteristic of common mode

7.3 Timing Specifications of segment mode

At Ta = +20°C, V_{DD} = +5.0V±5%, GND = 0V

Table 6

Symbol	Parameter	Min.	Typ.	Max.	Unit
t _{WCKH}	Shift clock "H" pulse width	-	4.6	-	us
t _{WCKL}	Shift clock "L" pulse width	-	8.4	-	us
t _{WLPH}	Latch pulse "H" pulse width	-	5.3	-	ms
t _R	Input signal rise time	-	36	-	ns
t _F	Input signal fall time	-	32	-	ns
t _{SD}	DISPOFF removal time	-	400	-	ns
t _{WDL}	DISPOFF enable pulse width	-	53	-	ms

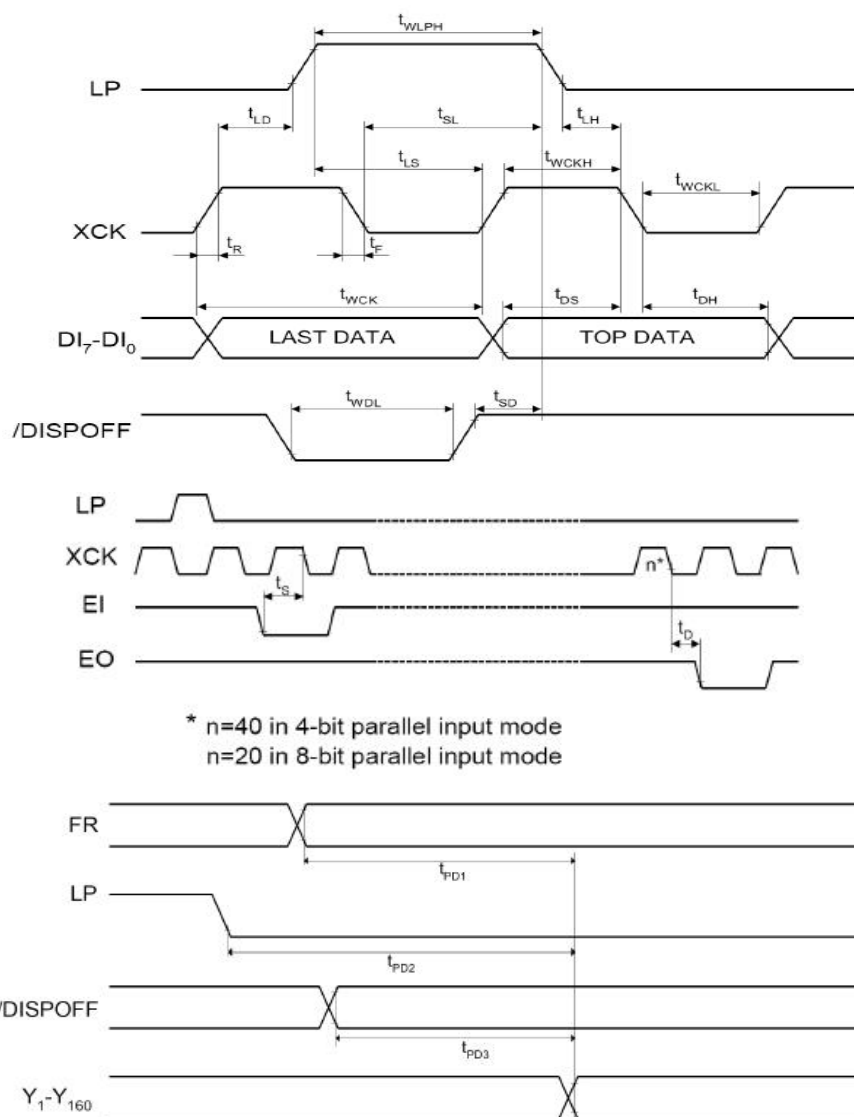

Figure 4: Timing characteristic of segment mode

8. Specification OF Quality Assurance

AQL inspection standard

Sampling method: Level II, single sampling

Defect classification

Classify	Item		Note	AQL
Major	Display state	Short or open circuit	1	0.65
		Contrast defect (dim, ghost)		
		LC leakage		
		Flickering		
		No display		
		Wrong viewing direction		
	Wrong Back-light	7		
	Non-display	Flat cable or pin reverse	9	
Wrong or missing component		10		
Minor	Display state	Background color deviation	2	1.5
		Black spot and dust	3	
		Line defect	4	
		Scratch		
		Rainbow	5	
		Pin hole	6	
	Polarizer	Bubble and foreign material	3	
		Scratch	4	
	PCB	Scratch	4	
	Soldering	Poor connection	8	
	Wire	Poor connection	9	

Note on defect classification

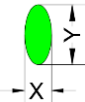
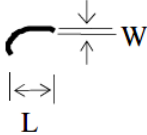
No.	Item	Criterion																				
1	Short or open circuit	Not allow																				
	LC leakage																					
	Flickering																					
	No display																					
	Wrong viewing direction																					
	Wrong Back-light																					
2	Contrast defect	Refer to approval sample																				
	Background color deviation																					
3	Point defect, Black spot, dust (incl. Polarizer) $\Phi = (X+Y)/2$	 <table border="1" data-bbox="898 1025 1394 1285"> <thead> <tr> <th>Point Size</th> <th>Acceptable Qty.</th> </tr> </thead> <tbody> <tr> <td>$\Phi \leq 0.10$</td> <td>Disregard</td> </tr> <tr> <td>$0.10 < \Phi \leq 0.20$</td> <td>3</td> </tr> <tr> <td>$0.20 < \Phi \leq 0.25$</td> <td>2</td> </tr> <tr> <td>$0.25 < \Phi \leq 0.30$</td> <td>1</td> </tr> <tr> <td>$\Phi > 0.30$</td> <td>0</td> </tr> </tbody> </table> <p style="text-align: center;">Unit: mm</p>	Point Size	Acceptable Qty.	$\Phi \leq 0.10$	Disregard	$0.10 < \Phi \leq 0.20$	3	$0.20 < \Phi \leq 0.25$	2	$0.25 < \Phi \leq 0.30$	1	$\Phi > 0.30$	0								
Point Size	Acceptable Qty.																					
$\Phi \leq 0.10$	Disregard																					
$0.10 < \Phi \leq 0.20$	3																					
$0.20 < \Phi \leq 0.25$	2																					
$0.25 < \Phi \leq 0.30$	1																					
$\Phi > 0.30$	0																					
4	Line defect	 <table border="1" data-bbox="916 1464 1410 1697"> <thead> <tr> <th colspan="2">Line</th> <th>Acceptable Qty.</th> </tr> <tr> <th>L</th> <th>W</th> <th></th> </tr> </thead> <tbody> <tr> <td>---</td> <td>$0.015 \geq W$</td> <td>Disregard</td> </tr> <tr> <td>$3.0 \geq L$</td> <td>$0.03 \geq W$</td> <td rowspan="2">2</td> </tr> <tr> <td>$2.0 \geq L$</td> <td>$0.05 \geq W$</td> </tr> <tr> <td>$1.0 \geq L$</td> <td>$0.1 > W$</td> <td>1</td> </tr> <tr> <td>---</td> <td>$0.05 < W$</td> <td>Applied as point defect</td> </tr> </tbody> </table> <p style="text-align: center;">Unit: mm</p>	Line		Acceptable Qty.	L	W		---	$0.015 \geq W$	Disregard	$3.0 \geq L$	$0.03 \geq W$	2	$2.0 \geq L$	$0.05 \geq W$	$1.0 \geq L$	$0.1 > W$	1	---	$0.05 < W$	Applied as point defect
Line		Acceptable Qty.																				
L	W																					
---	$0.015 \geq W$	Disregard																				
$3.0 \geq L$	$0.03 \geq W$	2																				
$2.0 \geq L$	$0.05 \geq W$																					
$1.0 \geq L$	$0.1 > W$	1																				
---	$0.05 < W$	Applied as point defect																				
5	Rainbow	Not more than two color changes across the viewing area.																				

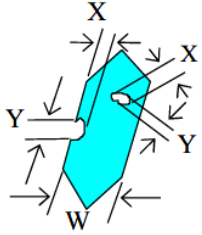
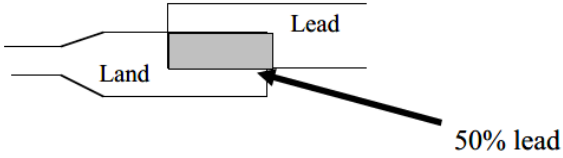
No.	Item	Criterion								
6	Segment pattern $W = \text{Segment width}$ $\Phi = (X+Y)/2$	(1) Pin hole $\Phi < 0.10\text{mm}$ is acceptable.  <table border="1" data-bbox="930 568 1348 730"> <thead> <tr> <th>Point Size</th> <th>Acceptable Qty</th> </tr> </thead> <tbody> <tr> <td>$\phi \leq 1/4W$</td> <td>Disregard</td> </tr> <tr> <td>$1/4W < \phi \leq 1/2W$</td> <td>1</td> </tr> <tr> <td>$\phi > 1/2W$</td> <td>0</td> </tr> </tbody> </table> <p style="text-align: right;">Unit: mm</p>	Point Size	Acceptable Qty	$\phi \leq 1/4W$	Disregard	$1/4W < \phi \leq 1/2W$	1	$\phi > 1/2W$	0
Point Size	Acceptable Qty									
$\phi \leq 1/4W$	Disregard									
$1/4W < \phi \leq 1/2W$	1									
$\phi > 1/2W$	0									
7	Back-light	(1) The color of backlight should correspond its specification. (2) Not allow flickering								
8	Soldering	(1) Not allow heavy dirty and solder ball on PCB. (The size of dirty refer to point and dust defect) (2) Over 50% of lead should be soldered on Land. 								
9	Wire	(1) Copper wire should not be rusted (2) Not allow crack on copper wire connection. (3) Not allow reversing the position of the flat cable. (4) Not allow exposed copper wire inside the flat cable.								
10	PCB	(1) Not allow screw rust or damage. (2) Not allow missing or wrong putting of component.								

9. Precaution for Using LCM

LCM is assembled and adjusted with a high degree of precision. Do not attempt to make any alteration or modification. The followings should be noted.

General Precautions:

1. LCD panel is made of glass. Avoid excessive mechanical shock or applying strong pressure onto the surface of display area.
2. The polarizer used on the display surface is easily scratched and damaged. Extreme care should be taken when handling. To clean dust or dirt off the display surface, wipe gently with cotton, or other soft material soaked with isopropyl alcohol, ethyl alcohol or trichloroethylene or acetone, do not use water, ketone or aromatics and never scrub hard.
3. Do not tamper in any way with the tabs on the metal frame.
4. Do not make any modification on the PCB without consulting RADIANT.
5. When mounting a LCM, make sure that the PCB is not under any stress such as bending or twisting. Elastomer contacts are very delicate and missing pixels could result from slight dislocation of any of the elements.
6. Avoid pressing on the metal bezel, otherwise the elastomer connector could be deformed and lose contact, resulting in missing pixels and also cause rainbow on the display.
7. Be careful not to touch or swallow liquid crystal that might leak from a damaged cell. Any liquid crystal adheres to skin or clothes, wash it off immediately with soap and water.

Static Electricity Precautions:

1. CMOS-LSI is used for the module circuit; therefore operators should be grounded whenever he/she comes into contact with the module.
2. Do not touch any of the conductive parts such as the LSI pads; the copper leads on the PCB and the interface terminals with any parts of the human body.
3. Do not touch the connection terminals of the display with bare hand; it will cause disconnection or defective insulation of terminals.
4. The modules should be kept in anti-static bags or other containers resistant to static for storage.

5. Only properly grounded soldering irons should be used.
6. If an electric screwdriver is used, it should be grounded and shielded to prevent sparks.
7. The normal static prevention measures should be observed for work clothes and working benches.
8. Since dry air is inductive to static, a relative humidity of 50-60% is recommended.

Soldering Precautions:

1. Soldering should be performed only on the I/O terminals.
2. Use soldering irons with proper grounding and no leakage.
3. Soldering temperature: $300^{\circ}\text{C}\pm 10^{\circ}\text{C}$
4. Soldering time: 3 to 4 second.
5. Use eutectic solder with resin flux filling.
6. If flux is used, the LCD surface should be protected to avoid spattering flux.
7. Flux residue should be removed.

Operation Precautions:

1. The viewing angle can be adjusted by varying the LCD driving voltage V_o .
2. Since applied DC voltage causes electro-chemical reactions, which deteriorate the display, the applied pulse waveform should be a symmetric waveform such that no DC component remains. Be sure to use the specified operating voltage.
3. Driving voltage should be kept within specified range; excess voltage will shorten display life.
4. Response time increases with decrease in temperature.
5. Display color may be affected at temperatures above its operational range.
6. Keep the temperature within the specified range usage and storage. Excessive temperature and humidity could cause polarization degradation, polarizer peel-off or generate bubbles.
7. For long-term storage over 40°C is required, the relative humidity should be kept below 60%. Avoid direct sunlight.